

Measuring Voltage and Current – Simulation and Real

In this lab you will measure the voltage and current through a real circuit using the myDAQ and compare those measurements to a simulation.

Niagara College Photonics Engineering Technology

No sector of business or industry remains untouched by photonics, the science of generating and harnessing light. The Photonics Engineering Technology program at Niagara College encompasses optics, lasers, electro-optics, spectroscopy and electronics technology.

Measuring Voltage and Current – Simulation and Real

Document content developed by:

Alexander McGlashan

Niagara College of Applied Arts and Technology

School of Technology, Department of Photonics

Measuring Voltage and Current – Simulation and Real

Purpose

In this lab you will measure the voltage and current through a real circuit using the myDAQ and compare those measurements to a simulation.

Parts Required:

1 - 560Ω resistor

1 – Red LED

1. In **Multisim** open a new **NI myDAQ design**

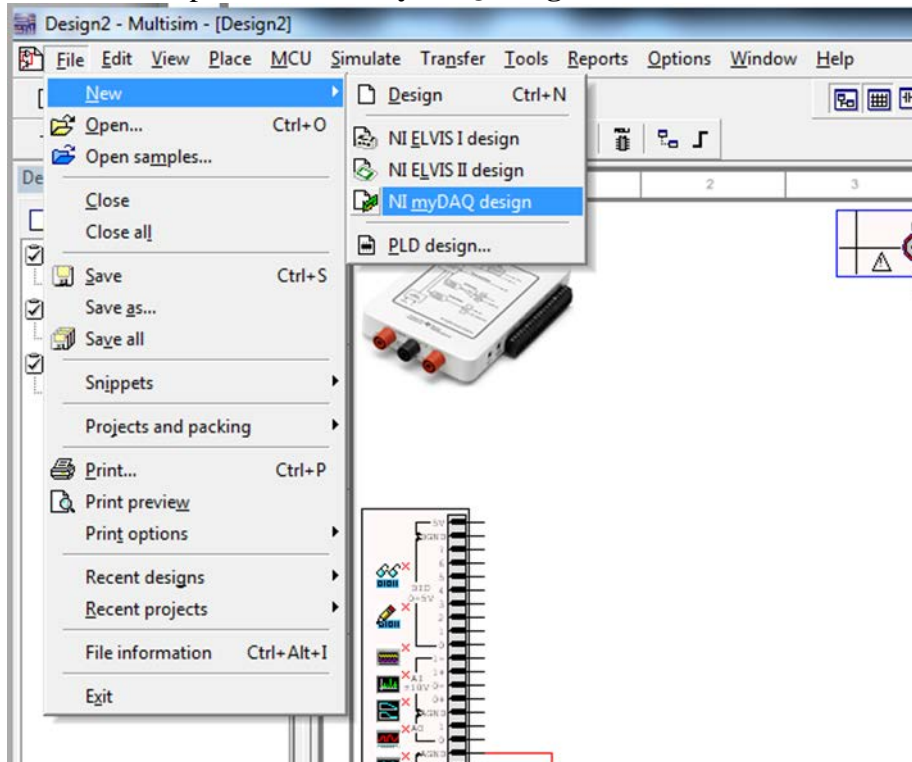

2. Create the following circuit using the myDAQ +15V source as the supply voltage:

Schematic Diagram

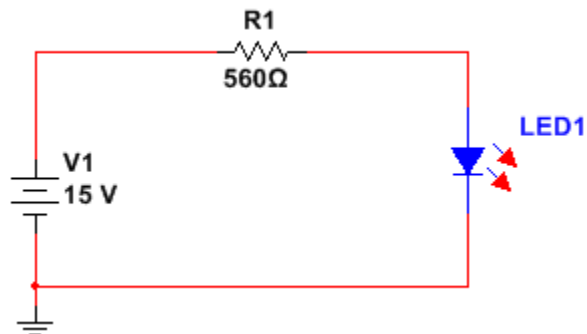

Multisim Layout

Measuring Voltage and Current – Simulation and Real

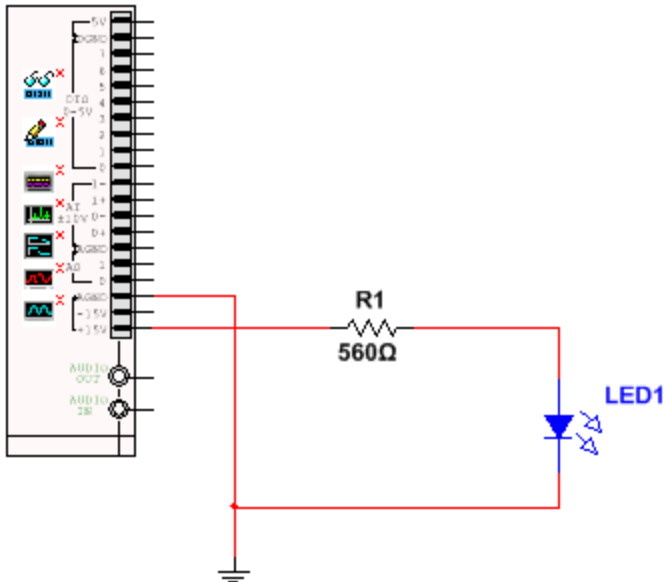

3. In your logbook create the following tables:

Simulated Results

	Across Source (from +15V to AGND)	Across R1	Across LED1
Voltage			

Current in Circuit	
--------------------	--

4. Connect the myDAQ DMM (in simulation mode) across each component in turn and measure/record the voltage across each device listed in the table. Then insert the DMM into the circuit and measure the current through the circuit (record your result).

Note: Screenshots of the measurements are shown at the conclusion of the lab if you run into difficulty taking your measurements.

Your results should be similar to the following:

Simulated Results

	Across Source (from +15V to AGND)	Across R1	Across LED1
Voltage	15.00 V	13.17 V	1.83V

Current in Circuit	23.51 mA
--------------------	----------

Measuring Voltage and Current – Simulation and Real

5. Try reversing the lead connection to the DMM. You'll notice that all your measurements will now appear as negative. This is why it is important for a schematic to provide a proper reference system so that you know how all the measurements should be referenced.

Most of our examples are fairly simple with the **HI** lead on the myDAQ connected to the most positive point and the **COM** lead to the most negative (or closest to common) being measured.

6. Construct the circuit on your breadboard and connect the **+15V** and **AGND** connections to the real myDAQ.

Typically the short lead of the LED is the cathode lead and should be connected towards the most negative potential (In this case connect it directly to **AGND**).

The **+15V** connection should be made to the side of the resistor not connected to the LED (just like in our schematic and simulation).

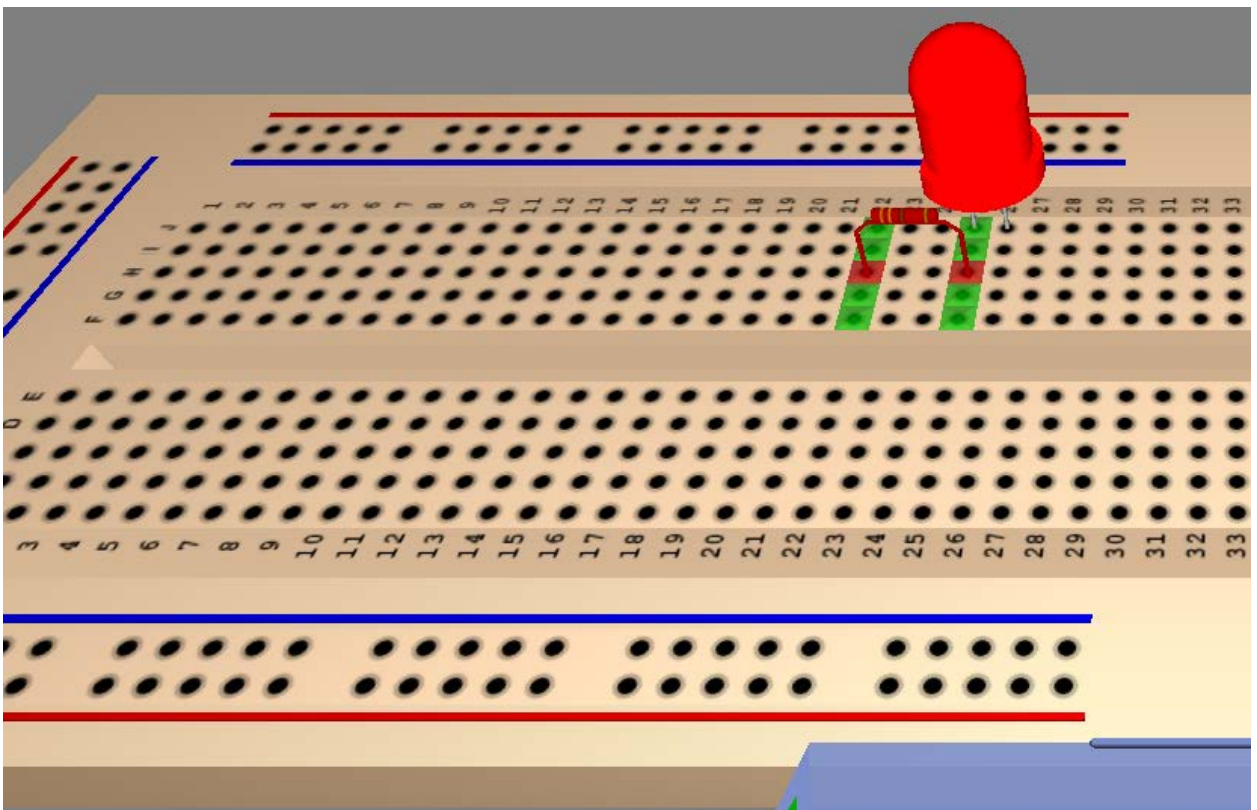

Measuring Voltage and Current – Simulation and Real

- Connect your myDAQ to the computer via the USB cable and then **select myDAQ1 (NI myDAQ)** under **Device** in the **Instrument Control** of the myDAQ multimeter.



- Create the following tables in your log book:

Measured Values of circuit with myDAQ

	Across Source (from +15V to AGND)	Across R1	Across LED1
Voltage			

Current in Circuit	
--------------------	--

- Select Run on the myDAQ multimeter and measure/record all the values in the table above (measuring the values in the real circuit).
- Compare your results to the simulated values. Create another table in your logbook and calculate the percentage error between the simulated and measured values. As a result of the myDAQ's low current capacity, the myDAQ's output voltage may "sag", resulting in a source voltage closer to 14V.

If the LED does not light, it is possible that you have inserted it backwards. Try reversing it.

Measuring Voltage and Current – Simulation and Real

Suggestions on taking your measurements:

Voltage Across Source

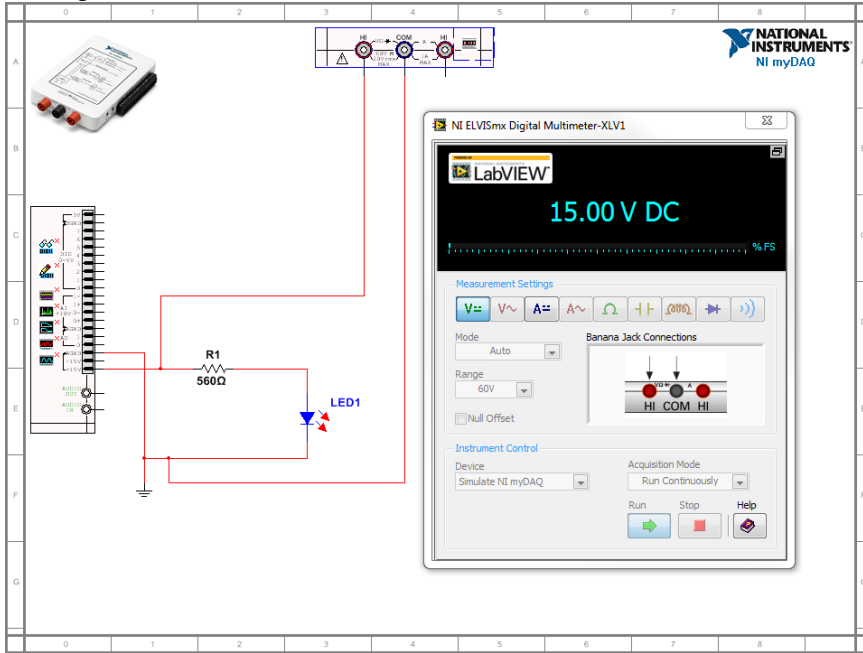

Voltage Across R1

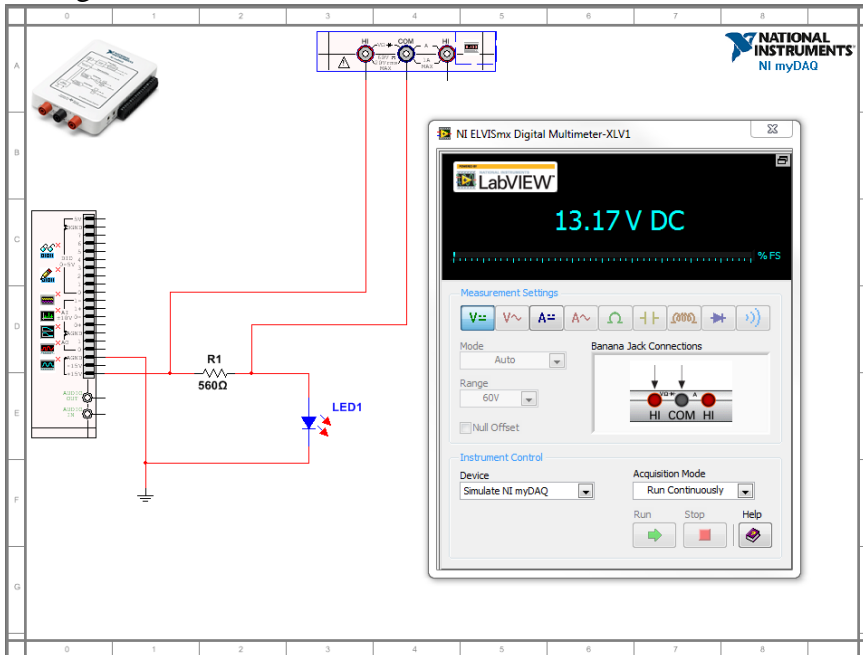

Measuring Voltage and Current – Simulation and Real

Voltage Across LED

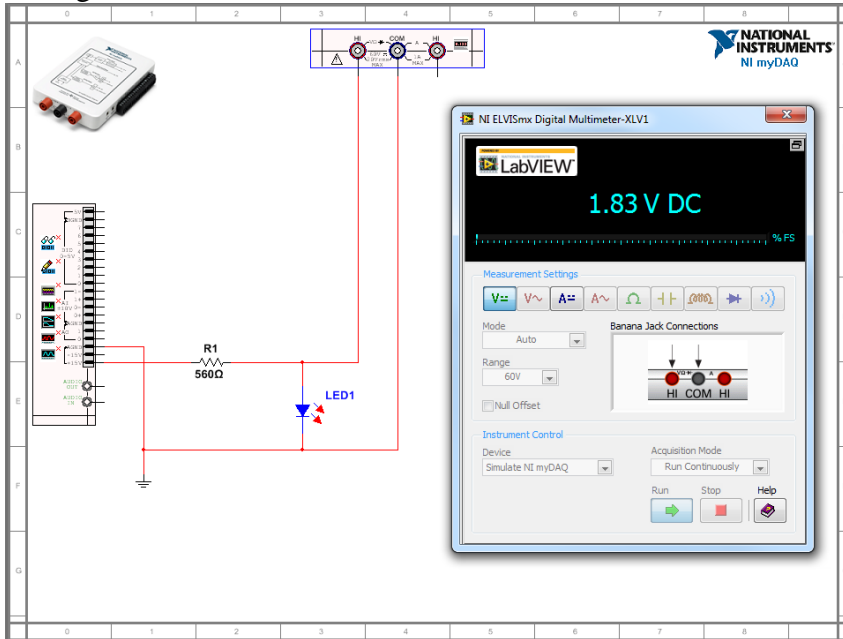

Current Through Circuit

(Note: Since there is only one path for current flow, the current can be measured at any point in the circuit)

